

**QUARTZ**  
EV FLUID

Making way for  
cleaner mobility



**TotalEnergies**



# Summary

<b>TotalEnergies, a broad energy company</b>	<b>4</b>	<b>Quartz EV Fluid product range</b>	<b>14-27</b>
<b>What are electric vehicles?</b>	<b>6-9</b>	<b>E-transmission fluids</b>	<b>16-23</b>
Hybrid Electric Vehicles (HEVs)	7	Quartz EV-Drive R	19
Plug-in Hybrid Electric Vehicles (PHEVs)	8	Quartz EV-Drive MP	20
Battery Electric Vehicles (BEVs)	8	Quartz EV-AT	21
<b>Quartz EV Fluid, making way for cleaner mobility</b>	<b>10</b>	Quartz EV-DHT	22
<b>New EV Fluid requirements</b>	<b>12-13</b>	Quartz EV-DCT	23
		<b>Thermal management fluids</b>	<b>24-26</b>
		Quartz EV-Battery	24-25
		Quartz EV-Battery D (for Direct cooling)	24
		Quartz EV-Battery I (for Indirect cooling)	25
		Quartz EV-Motor	26
		<b>Grease EV</b>	<b>27</b>
		Quartz EV-Grease	27

# TotalEnergies, a broad energy company

## TotalEnergies, a broad energy company

Energy is reinventing itself, Total is becoming TotalEnergies. TotalEnergies is a broad energy company that produces and markets energies on a global scale: oil and biofuels, natural gas and green gases, renewables and electricity. Our **105,000 employees** are committed to energy that is ever more affordable, clean, reliable and accessible to as many people as possible.

Active in more than **130 countries**, TotalEnergies puts sustainable development in all its dimensions at the heart of its projects and operations to contribute to the well-being of people.

## A leading global energy company

TotalEnergies' Marketing & Services business segment offers its professional and private customers a wide range of broad energy products and services - petroleum products, biofuels, charging and related services for electric vehicles, gas for road and maritime transportation - to support them in their mobility and help them reduce their carbon footprint.

Every day, over **8 million customers** visit our **16,000 service-stations** all over the world. As the world's number four in lubricants, we design and sell high performance products for the automotive, industrial and maritime sectors. And to provide the best response to the needs of our B2B customers, we deploy our sales forces, our international logistics network and our diverse offering. We operate in **107 countries**, where our **31,000 employees** stand close to all of our customers.

## Cutting edge R&D in lubricant innovation, responding to a changing automotive industry

In light of the profound changes shaping the automotive industry and the major political and economic stakes involved, TotalEnergies Lubrificants anticipated emerging market needs early on and started developing new types of fluids to meet vehicle manufacturers' expectations.

Thanks to this deep, years-long R&D commitment, TotalEnergies Lubrificants is now able to offer car manufacturers a new EV fluid range that will help them develop more efficient hybrid and electric vehicles and keep them running in optimal condition.

**QUARTZ**  
EV FLUID

TotalEnergies in pole  
position on electric  
with DS-TECHEETAH

DS AUTOMOBILES  
FORMULA-E TEAM  
TECHEETAH

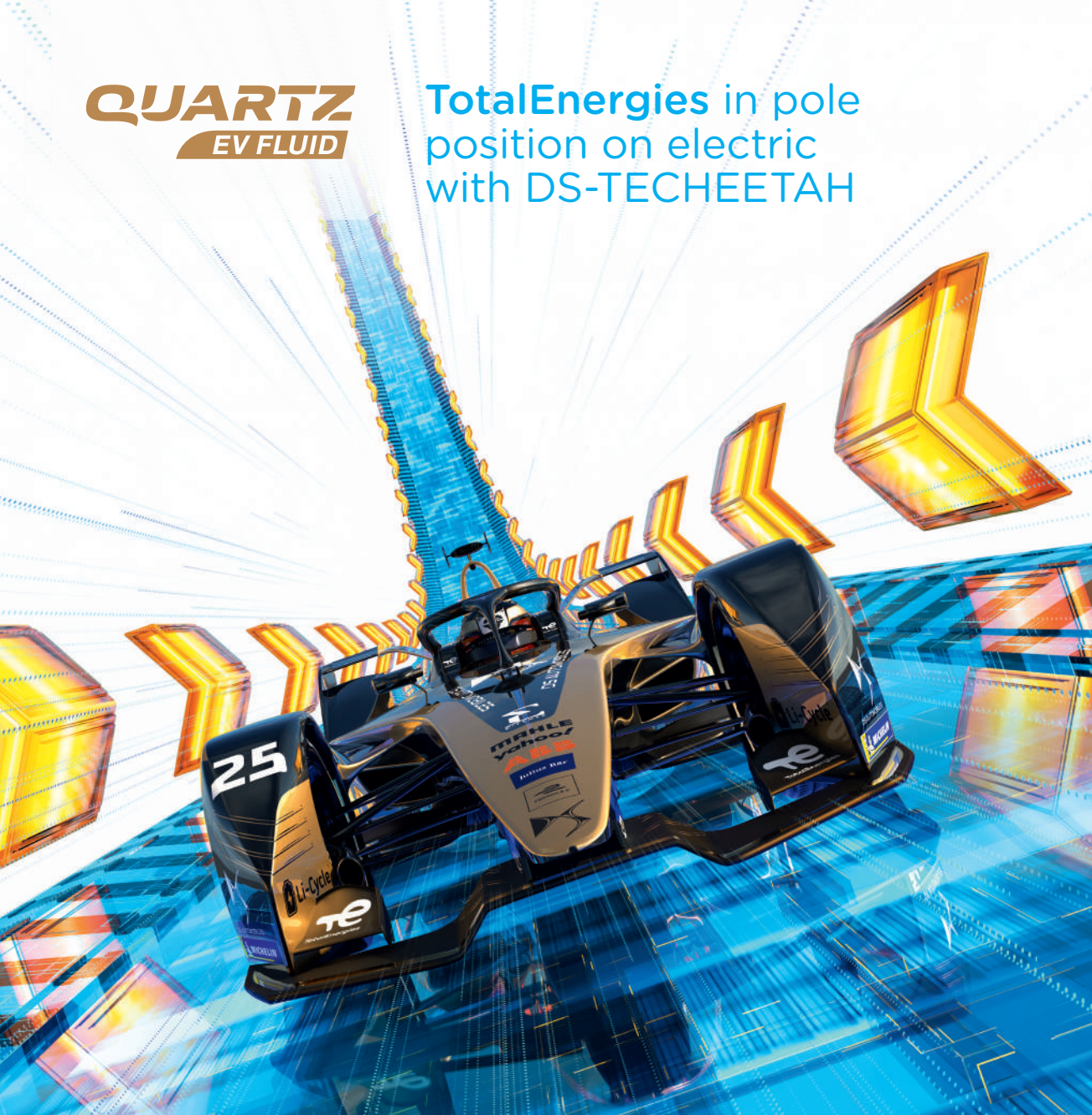

**TotalEnergies**

[lubricants.totalenergies.com](https://lubricants.totalenergies.com)

# What are electric vehicles?

In the market, three types of Electric Vehicles (EV) are identified:

- Hybrid Electric Vehicles (HEVs)
- Plug-in Hybrid Electric Vehicles (PHEVs)
- Battery Electric Vehicles (BEVs)

## Hybrid Electric Vehicle (HEVs)

A hybrid electric vehicle (HEV) is one of the solutions to reduce fuel consumption and respond to climate issues. The hybrid electric vehicle is equipped with an internal combustion engine and an electric motor. Two different sources of energy can be used: fuel and/or electricity.

## Different types of hybrid electric vehicles

Hybrid Electric Vehicles can be classified according to the level of hybridization, that is to say, the importance of the electrical part compared to the thermal engine.

### Micro hybridation S&S

The vehicle is equipped with Start & Stop and a battery charging system that uses the energy recovered during braking. Batteries are designed with a voltage of 12V.

### MHEV Mild Hybrid Electrical Vehicles

The electric motor recovers the kinetic energy that is generated when braking and uses it to recharge the battery. This energy is used during Start & Stop and for extra power when needed. Batteries are designed with a voltage between 48V and 160V.

### FHEV Full Hybrid Electrical Vehicles

The vehicle can run solely on its electric motor, without running the conventional ICE, typically during very light cruising and light acceleration. When additional power is needed, ICE provides full power. Batteries, recharged during braking, have a voltage between 200V and 300V.

In a **hybrid electric vehicle**, the electric motor can be positioned in different locations:

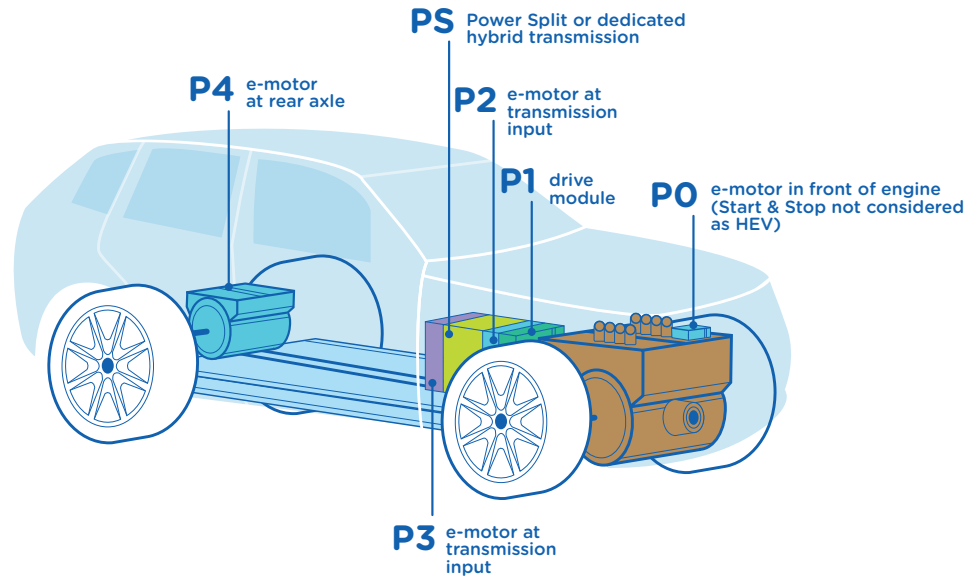

- P1** The electric motor is connected to the thermal engine and is able to recover energy when the car brakes and uses it to start the car and accelerate.
- P2** The electric motor is positioned before the gearbox or included in the transmission and is able to recover energy when the car brakes and uses it to start the car. The electric motor is able to uncouple from the thermal engine for an all-electric drive.
- P3** The electric motor is positioned after the gearbox and is able to recover energy when the car brakes and uses it to start the car. The electric motor is able to uncouple from the thermal engine for an all-electric drive.

- P4** The electric motor is integrated into the rear axle (e-axle), and is able to recover energy when the car brakes and uses it to start the car. The electric motor is able to uncouple from the thermal engine for an all-electric drive.

- PS** Power Split  
The gearbox uses a set of planetary gears with one or two electric motor(s) and is designed specifically for an electric use. The electric motor is able to recover energy when the car brakes and uncouple from the thermal engine for an all-electric drive.





## Plug-in Hybrid Electric Vehicles (PHEVs)

A Plug-in Hybrid Electric Vehicle is a vehicle with the same characteristics of a FHEV, but batteries can be recharged on the electrical grid. Batteries have a voltage between 300V and 400V (up to 800V), increasing the driving capacity in full electric mode.

## Battery Electric Vehicle (BEVs)

A Battery Electric Vehicle (BEV) uses one or two electric motors powered by electrical energy, stored in batteries. The electric motor converts electrical energy into mechanical energy with an efficiency of around 80%, while Internal Combustion Engine only achieves 35% of efficiency. Batteries are energy accumulators and are the electric car's main technological challenge.

Major objectives of a battery are : high energy density, reduced charging time and lower cost.

The lithium-ion battery is the most commonly used technology. The electric engine does not require the use of standard complex gearboxes, which are otherwise necessary in today's vehicles. A reducer equipped with one or two speeds is used to transfer the electric motor's mechanical power to the wheels.

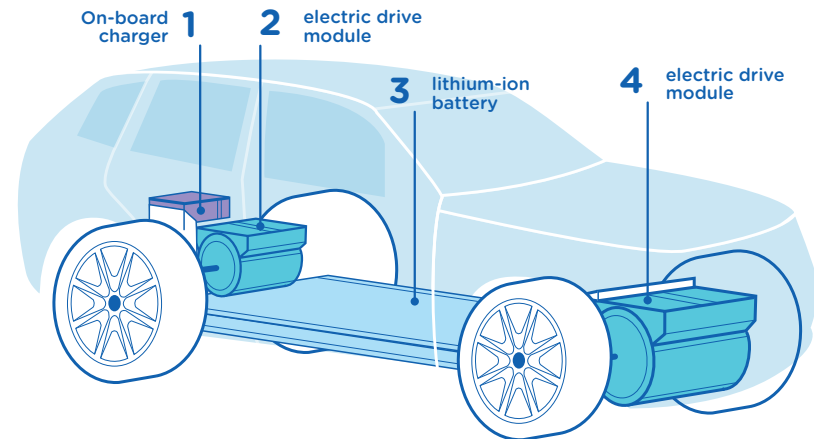



## As a summary, three different types of Electric Vehicles are coexisting with different technical requirements:

### Hybrid Electric Vehicles (HEVs)

Vehicle that uses an electric motor to assist a fuel-powered engines. The energy is mainly generated by the fuel (Gasoline or Diesel).

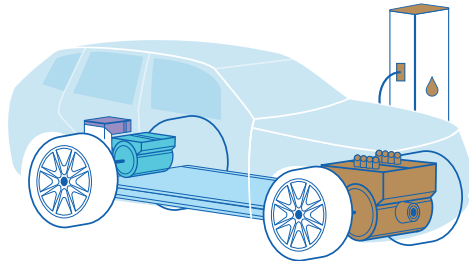

### Plug-in Hybrid Electric Vehicles (PHEs)

Evolution of HEV, vehicle that uses a combination of a thermal engine, with a more powerful electric system (larger battery and more efficient electric motor). The vehicle can be charged by using electrical grid.

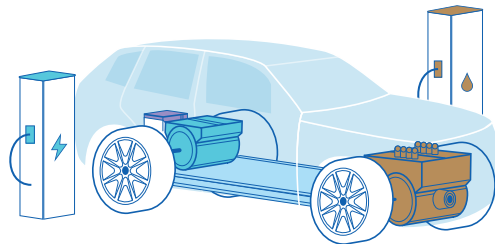

### Battery Electric Vehicles (BEVs)

Vehicle exclusively powered by an electric battery, thanks to an efficient electric motor. As a full electric vehicle, this new generation of car produces zero direct tailpipe emissions.

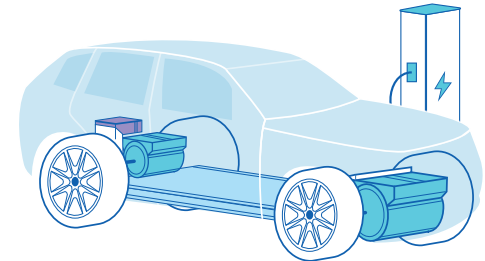

# Quartz EV fluid, making way for cleaner mobility

**Today's environmental challenges and the resulting regulations are forcing the automotive industry to innovate constantly while responding to user expectations for quality and performance.**

At TotalEnergies Lubrificants, we have always worked together with our customers to develop tailored solutions that meet their specific needs and to guarantee optimum operation and maintenance for their vehicles and equipment.

**TotalEnergies Lubrificants: committed to cleaner mobility.**

As a trusted partner to car manufacturers, TotalEnergies Lubrificants aims to become the responsible energy major. This explains our longstanding commitment to delivering technical, people-oriented solutions and sustainable performances. Our goal is to promote cleaner mobility that is better for both people and the environment. In 2018, following a major R&D formulation effort, TotalEnergies was very proud to become the first oil marketer to commercialize a dedicated product portfolio to Electric Vehicles.

Three new highly innovative product ranges meeting vehicle manufacturers' needs that will help them design increasingly efficient electric and hybrid vehicles: **Quartz EV Fluid** for light vehicles, **Hi-Perf EV Fluid** for motorcycles and **Rubia EV Fluid** for heavy vehicles. These high-performance fluids can keep vehicles running smoothly from the time they roll off the assembly line to the end of their useful lives.

**Quartz EV Fluid range for Hybrid and Electric vehicles.**

As hybrids and EVs become increasingly powerful and their battery ranges and charging speeds improve, standard fluids are unable to keep up in terms of robustness, heat resistance and cooling capacity.

**Quartz EV Fluid** is the first fluid range in the market that responds to these vehicles' specific requirements, as well as to their related electrical, thermal and friction constraints.

**Quartz EV Fluid, pioneering electrical lubrication.**

**QUARTZ**  
EV FLUID

Driving lubricants  
innovation



**TotalEnergies**

[lubricants.totalenergies.com](https://lubricants.totalenergies.com)

# New EV Fluid requirements

**Hybrid Electric Vehicles (HEVs)** and **Plug-in Hybrid Electric Vehicles (PHEVs)** are equipped with an Internal Combustion Engine (ICE) and an electric motor. Two different sources of energy can be used: fuel and/or electricity.

**Battery Electric Vehicles (BEVs)** use one or two electric motors powered by electrical energy, stored in batteries.

The electric motor converts electrical energy into mechanical energy with an efficiency of around 90%, while Internal Combustion Engine only achieves 35% of efficiency.

The new technical constraints for the electrification of vehicles require the development of new fluids that must meet the following properties:

## Dielectric properties

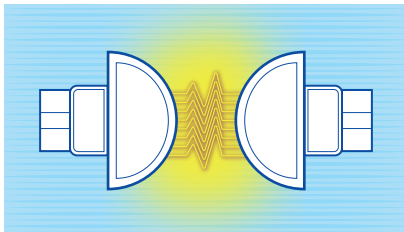

Fluids used in electric vehicles require electrical insulation properties. The fluid must be insulating to prevent any arcing since it is going to be in close contact with the electrical and/or electronic components of the vehicle.

## Compatibility with materials

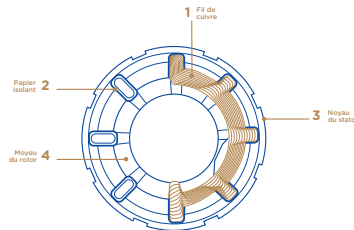

The fluid and new components of the electric vehicle are in direct contact. New challenges must be faced in terms of the fluid being compatible with different types of materials in order to avoid swelling, breakage, corrosion etc. Copper is a key material for these applications.

## Thermal properties

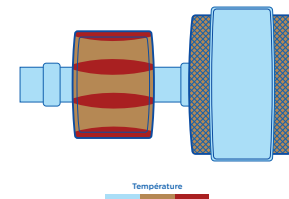

Power electronics and the electric engine must operate within a defined temperature range. Operating at higher than the desired temperature range inevitably reduces the vehicles' service life, efficiency and power. The fluid must therefore ensure efficient heat evacuation at temperatures up to 180°C.

Electric vehicles are a concentrate of innovation with high new technical requirements. As a result of TotalEnergies' commitment to continuous innovation, our **Quartz EV Fluid** range introduces very unique technological benefits to reach a new level of performance in the EVs market.



## INSULAT·ION AUGMENTED

Prevent Short-circuits  
and Static Charge build-up



## THERMO·CONTROL AUGMENTED

Heat Transfer & Cooling  
Capability



## COMPATIBILITY AUGMENTED

Compatibility with Copper  
& Insulating Materials

# Quartz EV Fluid Product Range

E-transmission fluids

- Quartz EV-Drive R
- Quartz EV-Drive MP
- Quartz EV-AT
- Quartz EV-DHT
- Quartz EV-DCT

Thermal management fluids

- Quartz EV-Battery
  - Quartz EV-Battery D  
(for Direct cooling)
  - Quartz EV-Battery I  
(for Indirect cooling)
- Quartz EV-Motor

Grease EV

- Quartz EV-Grease





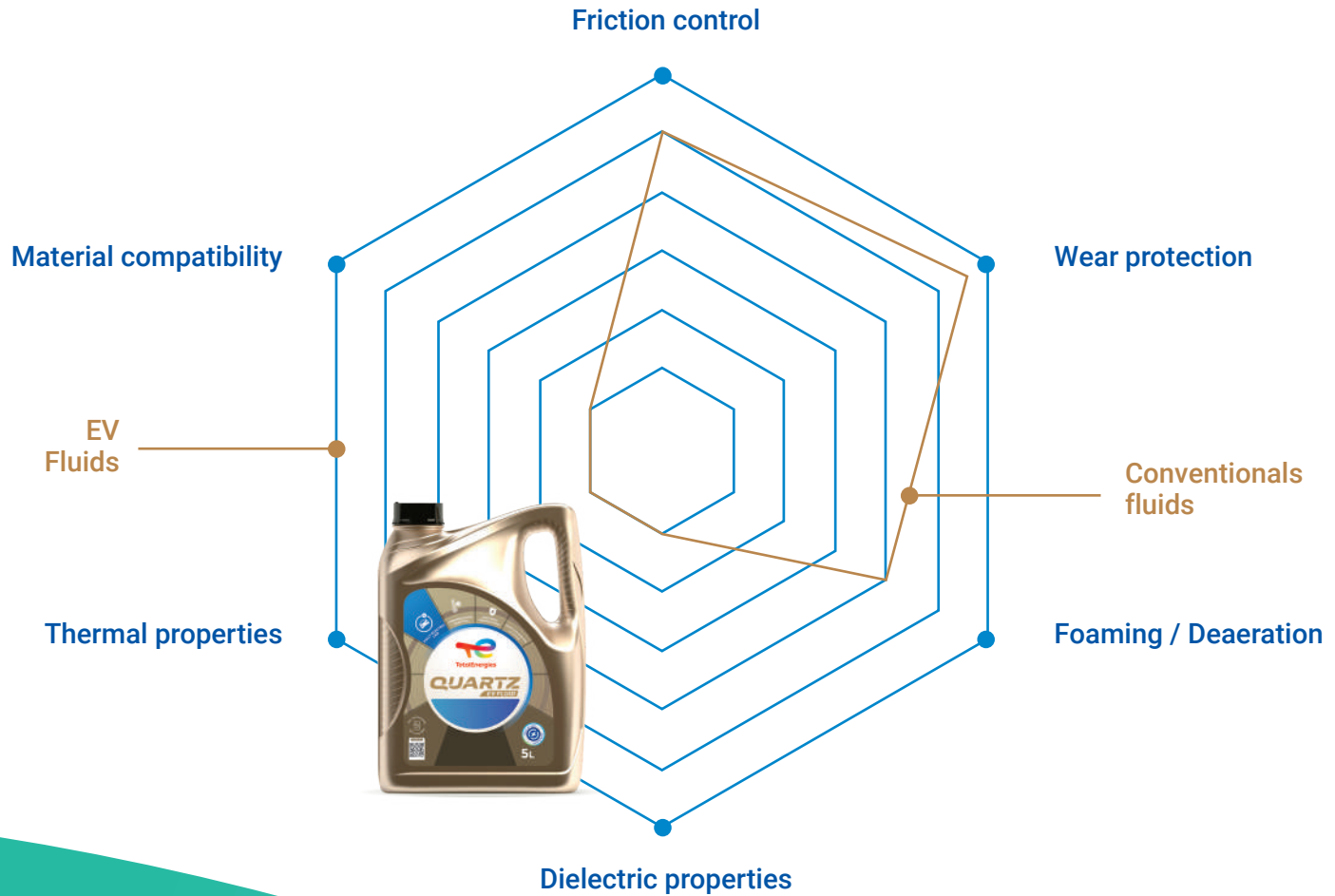



# Quartz EV Fluid Product Range

## E-transmission fluids

From various applications to TotalEnergies' platform approach:

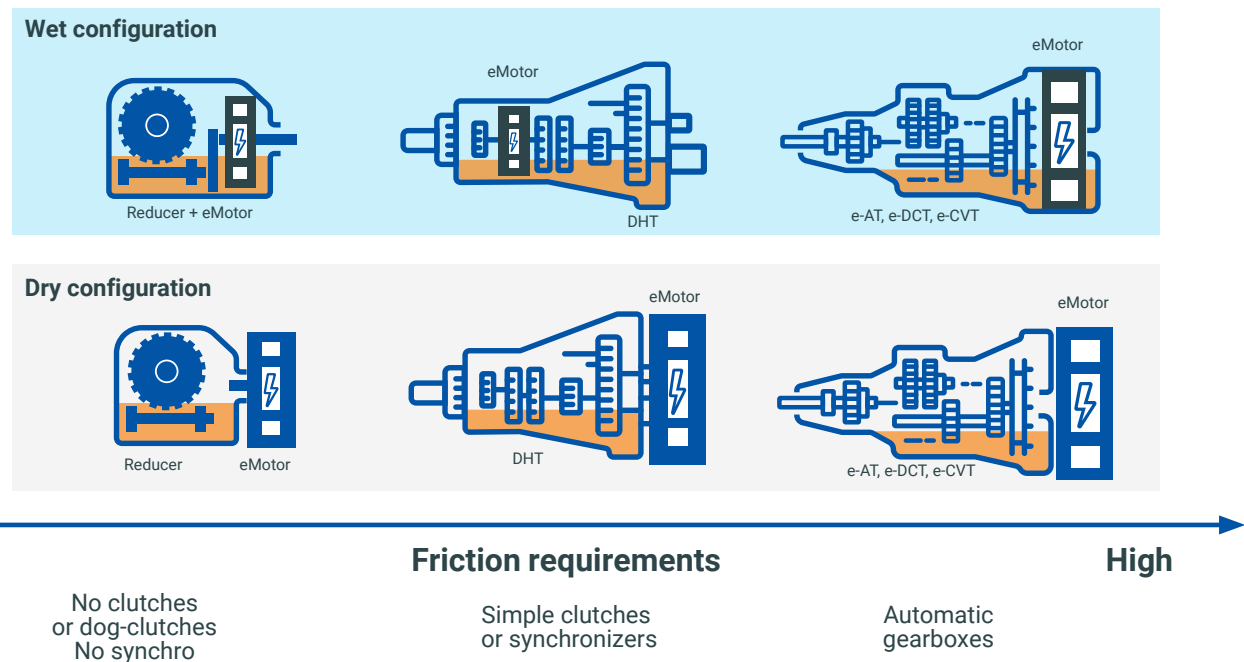

From various applications to TotalEnergies' platform approach...



# Quartz EV Fluid Product Range

## E-transmission fluids

Our global product portfolio offers improved dielectric properties after ageing.

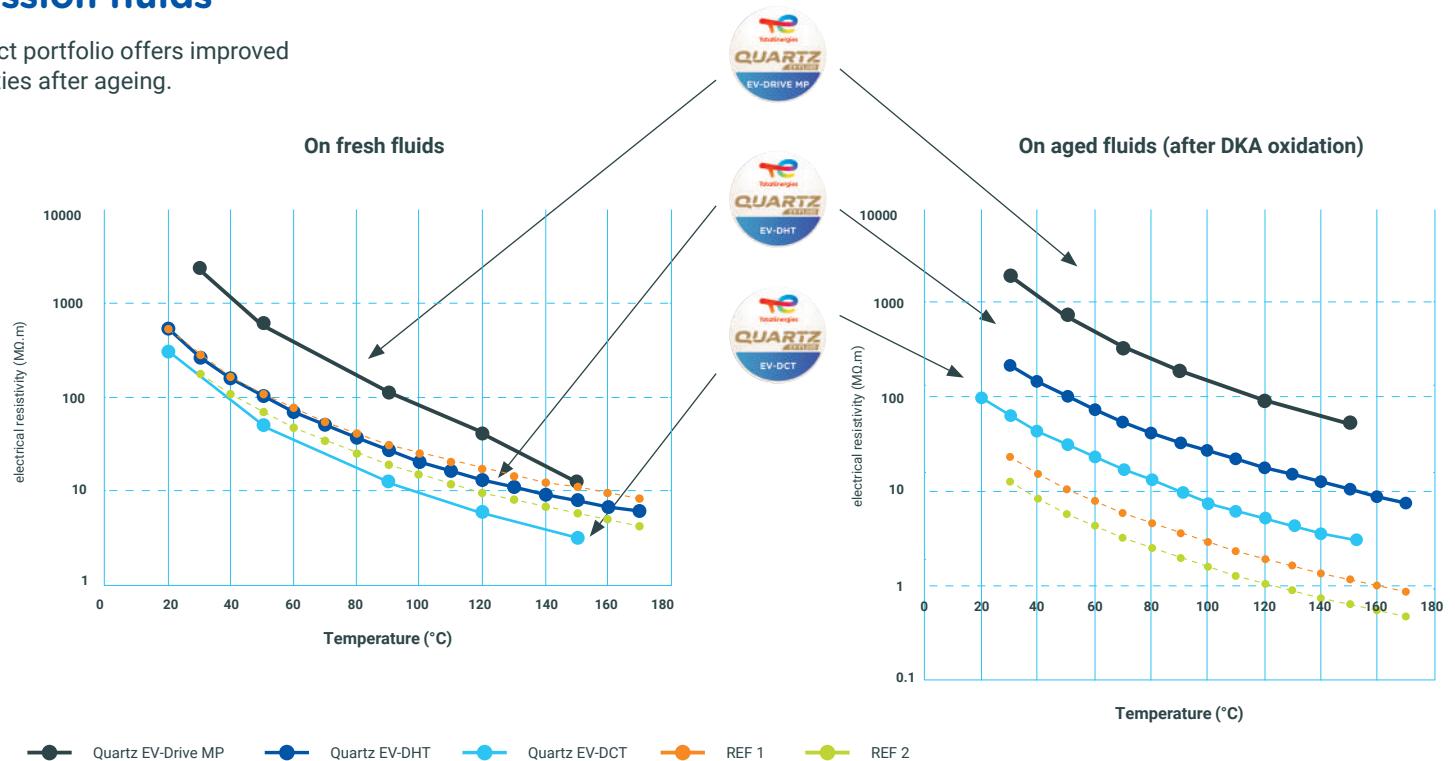

## E-transmission fluids

# Quartz EV-Drive R

Quartz EV-Drive R is specially designed with **Compatibility Augmented** technology for electric drivetrain reducers. This product is a synthetic fluid formulated for new generation of electric drivetrain reducers operating under extreme conditions.

**Compatibility Augmented** technology is embedded in order to fit perfectly with new material types such as high-performance polymers, thermoplastics and seals being used in electric transmissions.

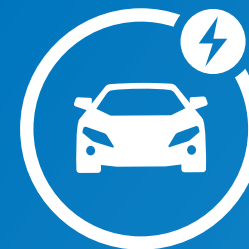

**BATTERY ELECTRIC  
VEHICLES**



Ensure durability of gears and rolling bearings rotating at very high speed



Show optimal anti-foaming and air release properties through the entire lifetime of the vehicles



Designed for excellent pumpability even at very low temperature

## E-transmission fluids

# Quartz EV-Drive MP

Quartz EV-Drive MP is specially designed with **Insulat.Ion Augmented** technology for **reducers, electric engines** and **power electronics**. This product fits perfectly with the requirements of those components with outstanding performances.

**Insulat.Ion Augmented** technology is designed to address specific electrical, thermal and friction constraints of electric powertrains. It insulates electric circuits' components to reduce wear, prevent shortcuts and improve vehicle performance.

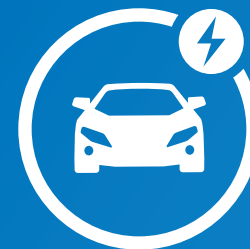

**BATTERY ELECTRIC  
VEHICLES**



Protect against short-circuits and static electricity



Provide optimal temperature control even at sharp acceleration and fast charging operation



Maintain excellent compatibility with copper coils and polymer material



Ensure excellent anti-wear properties for gears and rolling bearing

## E-transmission fluids

# Quartz EV-AT

Quartz EV-AT is specially designed with **Compatibility Augmented** technology for hybrid automatic transmissions.

**Compatibility Augmented** technology is designed with optimized formulation that is perfectly fitting with all hybrid electric transmission materials, providing maximum protection of copper and elastomer materials present in the e-transmission.

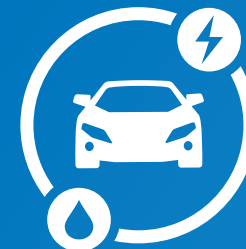

**HYBRID ELECTRIC  
VEHICLES  
PLUG-IN HYBRID ELECTRIC  
VEHICLES**



Ensure optimal level of friction and friction durability for a smooth gear shifting



Show optimal anti-foaming and air release properties through the entire lifetime of the vehicles



Ensure material compatibility with copper wires and elastomers



Designed for excellent pumpability even at very low temperature

## E-transmission fluids

# Quartz EV-DHT

Quartz EV-DHT is specially designed with **Compatibility Augmented** technology for electric dedicated hybrid transmission (e-DHT).

**Compatibility Augmented** technology embedded consists in a Sulphur-optimized additive technology which fits perfectly with all hybrid electric transmission materials, providing maximum protection of copper materials present in the e-transmission.

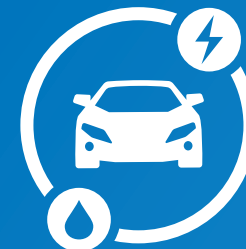

**HYBRID ELECTRIC  
VEHICLES  
PLUG-IN HYBRID ELECTRIC  
VEHICLES**



Ensure durability of gears and rolling bearings



Ensure material compatibility with copper wires and elastomers



Show optimal anti-foaming and air release properties through the entire lifetime of the vehicles



Designed for excellent pumpability even at very low temperature



Ensure optimal level of friction and friction durability for a smooth gear shifting



## E-transmission fluids

# Quartz EV-DCT

Quartz EV-DCT is specially designed with **Compatibility Augmented** technology for hybrid Dual Clutch transmissions.

**Compatibility Augmented** technology is designed with optimized formulation that is perfectly fitting with all hybrid electric transmission materials, providing maximum protection of copper and elastomer materials present in the e-transmission.

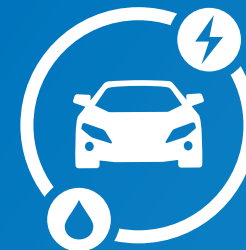

**HYBRID ELECTRIC  
VEHICLES  
PLUG-IN HYBRID ELECTRIC  
VEHICLES**



Ensure durability of gears and rolling bearings



Ensure material compatibility with copper wires and elastomers



Show optimal anti-foaming and air release properties through the entire lifetime of the vehicles



Designed for excellent pumpability even at very low temperature



Ensure optimal level of friction and friction durability for a smooth gear shifting

Thermal management fluids

# Quartz EV-Battery

**Quartz EV-Battery** is a series of fluids specifically designed for lithium battery cooling technology. These fluids offer a high level of cooling performance allowing the cells to accept high charge currents and reduce the risk of thermal runaway propagation of a lithium battery.

**Quartz EV-Battery** is specially designed with **Thermo.Control Augmented technology**. Thermo-Control Augmented technology is designed to allow the battery to maintain an optimal temperature throughout its usage, ensuring maximum battery efficiency. **Quartz EV-Battery introduces two different technologies of product:**

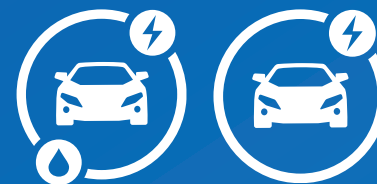

**HYBRID ELECTRIC  
VEHICLES  
PLUG-IN HYBRID ELECTRIC  
VEHICLES  
BATTERY ELECTRIC  
VEHICLES**

## Quartz EV-Battery D

**Quartz EV-Battery D**, for Direct cooling.  
Thanks to Quartz EV-Battery D, an innovative solution of battery cooling is disrupting the electric vehicles market. Quartz EV-Battery D offers powerful cooling benefits using a direct cooling approach.

## Quartz EV-Battery I

**Quartz EV-Battery I**, for Indirect cooling. Based on an improved water/glycol technology, Quartz EV-Battery I is a high-performance fluid ensuring a thermal management control of the battery by indirect cooling.



## Quartz EV-Battery D



Protect against the risk of fire and cell thermal runaway propagation thanks to a very high thermal stability of the fluids



High cooling efficiency with a low volume of fluid



Preserve the environment and risk of injury by an absence of fluid toxicity



Provide high level of stability in time



## Quartz EV-Battery I



Reduced electrical conductivity to mitigate hydrogen formation



High cooling efficiency with inherently thermal properties



Compatibility and easy implementation with standard BEV components



Balanced corrosion protection

## Thermal management fluids

# Quartz EV-Motor

Quartz EV-Motor is specially designed with **Thermo-Control Augmented** technology for electric motor of high-power densities. This product is a high-performance fluid for e-motor direct-cooling.

**Thermo-Control Augmented** technology is designed to provide the necessary heat removal performance from the most critical areas of e- motors, such as the coils and rotor. It maintains optimal temperature throughout e-motor usage, ensuring maximum efficiency.

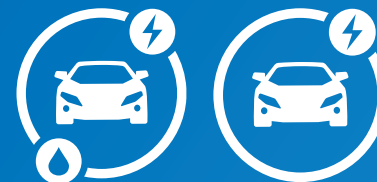

**HYBRID ELECTRIC  
VEHICLES  
PLUG-IN HYBRID ELECTRIC  
VEHICLES  
BATTERY ELECTRIC  
VEHICLES**



Protect against short circuits and static electricity



Provide optimal temperature control even at sharp acceleration



Ensure compatibility with copper coils and polymer materials



Ensure excellent durability for rolling bearings rotating at very high speed

Grease EV

# Quartz EV-Grease

**Quartz EV-Grease** is specially developed for EV vehicles with an innovative technology. This polyurea grease is dedicated to bearings. TotalEnergies premium Quartz EV- Grease ensures durability, reliability and efficiency in lubrication of all electric vehicles.

**Insulat-Ion Augmented** technology is designed to address specific electrical, thermal and friction constraints of electric powertrains. It insulates electric circuits' components to reduce wear, prevent shortcuts and improve vehicle performance.

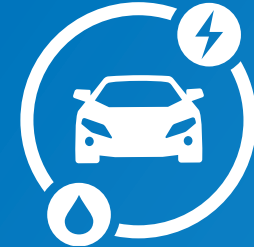

**HYBRID ELECTRIC  
VEHICLES**



Protect for EDM  
(Electrical discharge machining)  
and white edge cracks



High speed,  
high and low temperature



Thixotropic behavior



Low torque, low friction,  
metal to metal protection



Reduce vibration level



**TotalEnergies**